

Conjunto Dobradiça S95 105° Soft Clip ACT3



Componente

Item	Componente	Quant.
1	Dobradiça	01
2	Calço	01

Dados do Produto

Fixação Calço-Dobradiça	Clip-on
Ângulo de Abertura	105°
Mola	com amortecimento
Furação Caneco	Ø35x11.3
Entre Furos Caneco	52mm
Distância Fixação Calço	37mm
Entre Furos Calço	32mm
Fixação	com parafusos / com bucha (opcional)

Referência dobradiças peso/altura

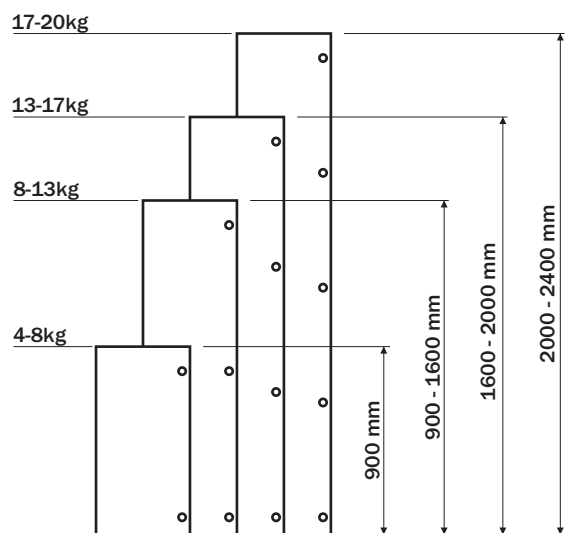

Valores de referência para portas com largura máxima de 600mm

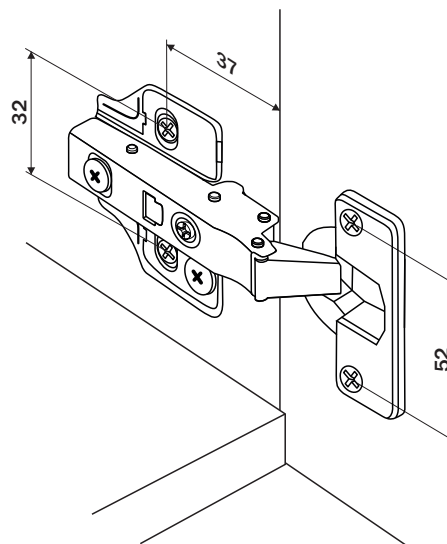

Regulagens

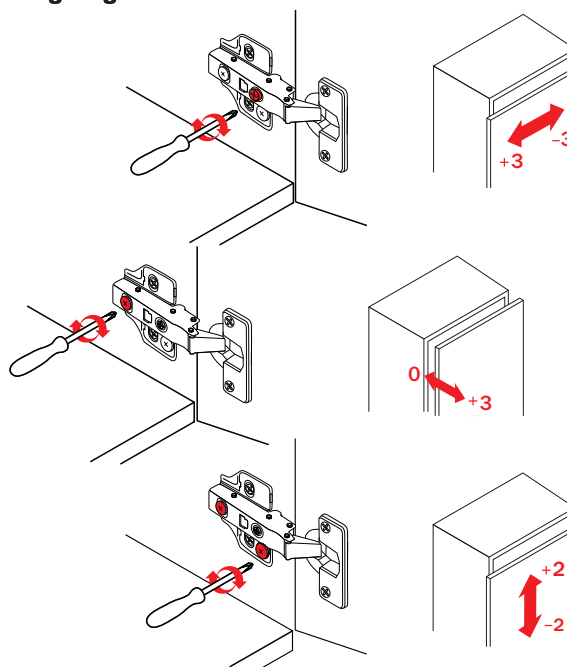

Recomenda-se que as regulagens necessárias para o alinhamento da porta sejam igualmente distribuídas entre todas as dobradiças, alcançando assim o balanceamento dos esforços entre elas.

A9501NI Corpo Baixo

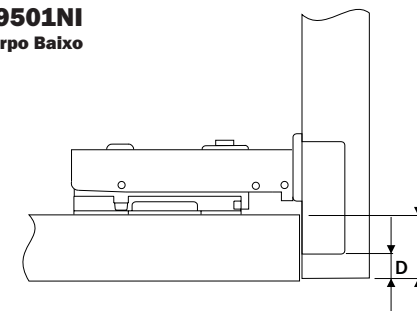

D	S
3	18
4	19
5	20
6	21

A9541NI Corpo Alto

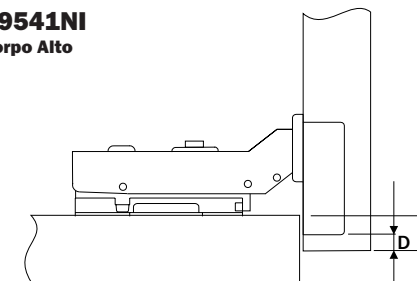

D	S
3	8
4	9
5	10
6	11

A9561NI Corpo Extra Alto

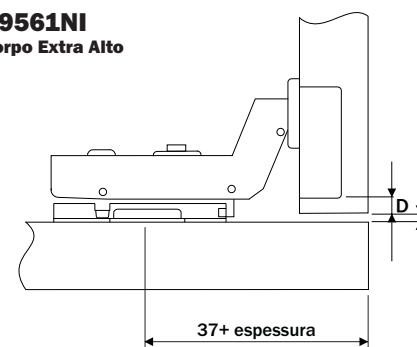

D	F
3	0
4	-1
5	-2

Conjunto Dobradiça S95 105° Soft Clip ACT3



Furação

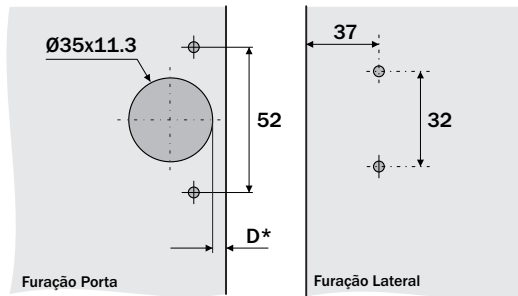

*Conforme Tabela pg 01

Pré - Montagem

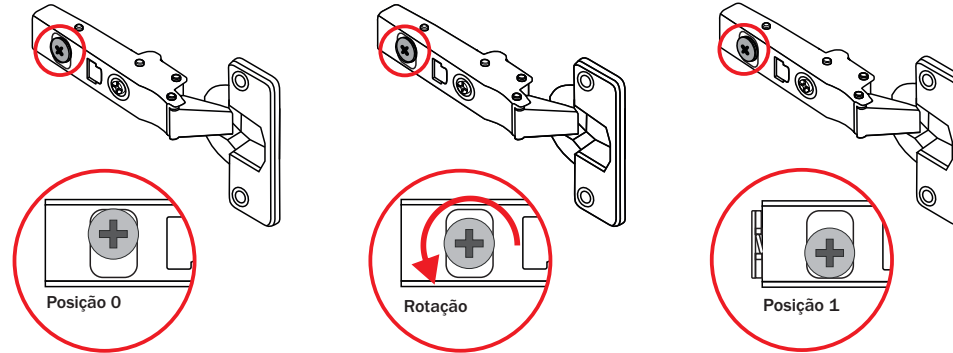

Para facilitar a montagem (dobradiça / calço) rotacione suavemente o parafuso de regulagem de profundidade horizontal no sentido anti-horário, da posição 0 (original) até a posição 1.

! Posição 0 e 1 são posições limites da regulagem. O giro do parafuso além destes pontos causará o rompimento do sistema. (anti-horário conforme posição do desenho)

Montagem do CLIP

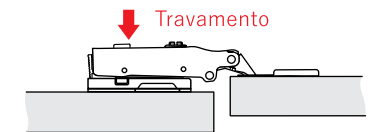
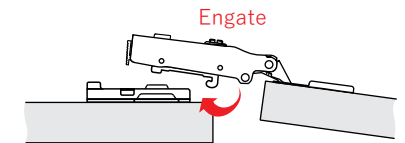

! A fixação da dobradiça e do calço devem ser feitas de forma independente.

Regulagem

A Horizontal (Recobrimento)

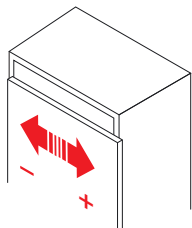
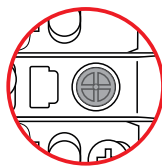
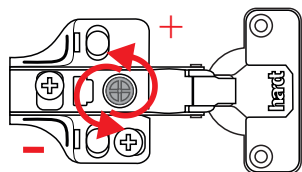

B Profundidade (Distância entre a porta e o armário)

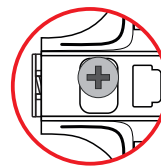
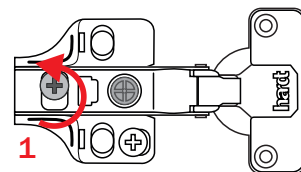
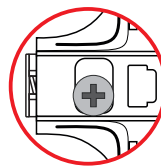
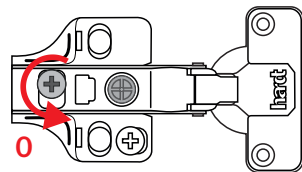

C Vertical

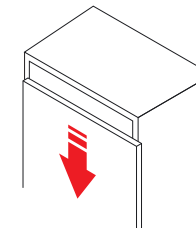
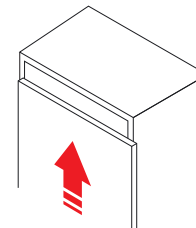
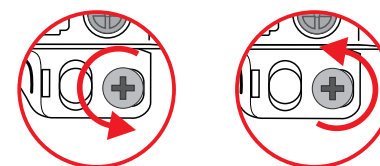
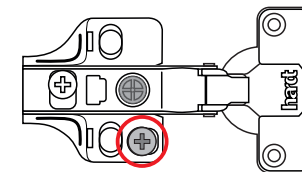

! Posição 0 e 1 do parafuso são posições limites da regulagem. O giro além destes pontos causará o rompimento do sistema. (anti-horário conforme posição do desenho)

Desmontagem do CLIP

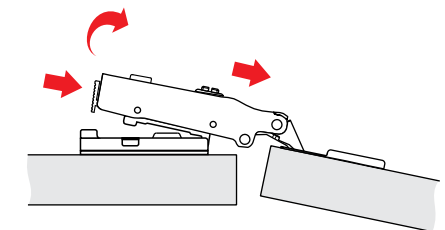

! Para a desmontagem posicione o parafuso de regulagem horizontal na posição 0.